



DSX Access Systems, Inc.

Lantronix UDS1100 – Device Installer

The Lantronix UDS1100 sold by DSX can be programmed through a serial connection or through a network connection using the Device Installer software that can be download from Lantronix here: <https://ts.lantronix.com/ftp/DeviceInstaller/Lantronix/4.4/4.4.0.7/Installers/SingleInstallFiles/DeviceInstaller-4407-SA.zip>

Use these instructions for programming the unit to be used with DSX.

1. Install Lantronix Device Installer
2. Select language
3. Click Install, Click Next
4. Select Installation location folder
5. Confirm Install.
6. Install complete Close, Click ok
7. Launch the Device Installer app
8. Click search icon

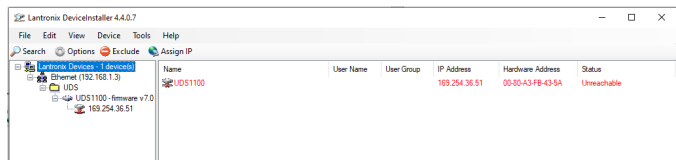

9. Click on discovered device

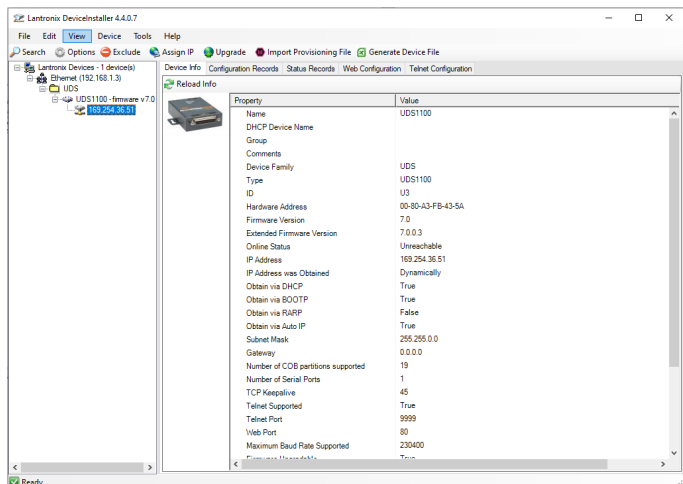

10. Click the telnet tab

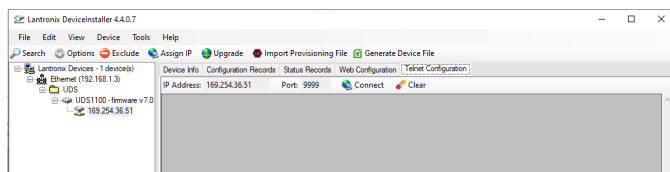

11. Click connect

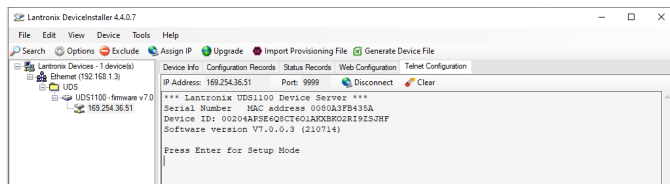

12. Click Enter for setup mode

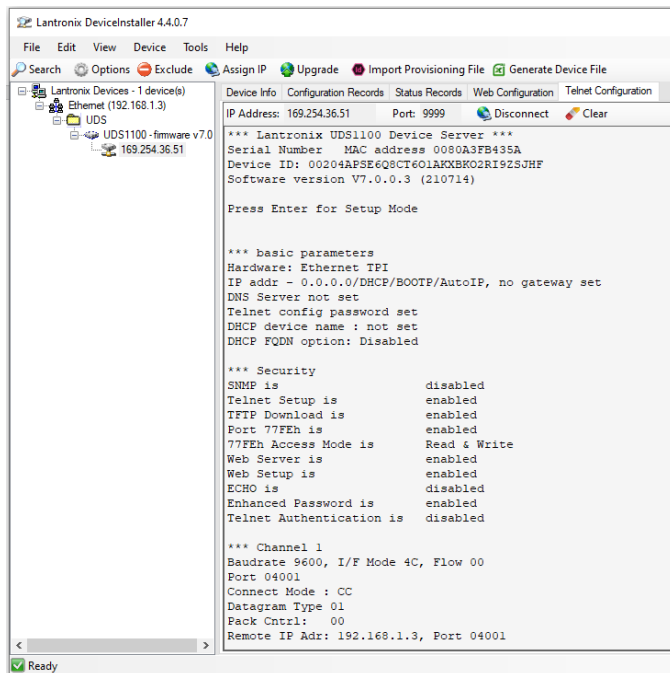

13. Setup mode appears with information (part 2 if scrolled down)

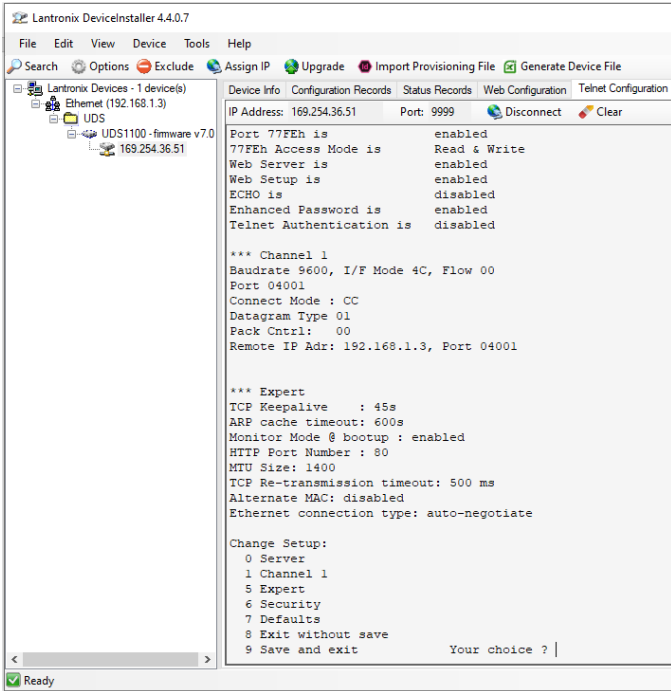

15. Assign an IP address for the Lantronix device and Type (.) to separate each octet then press enter for next line.

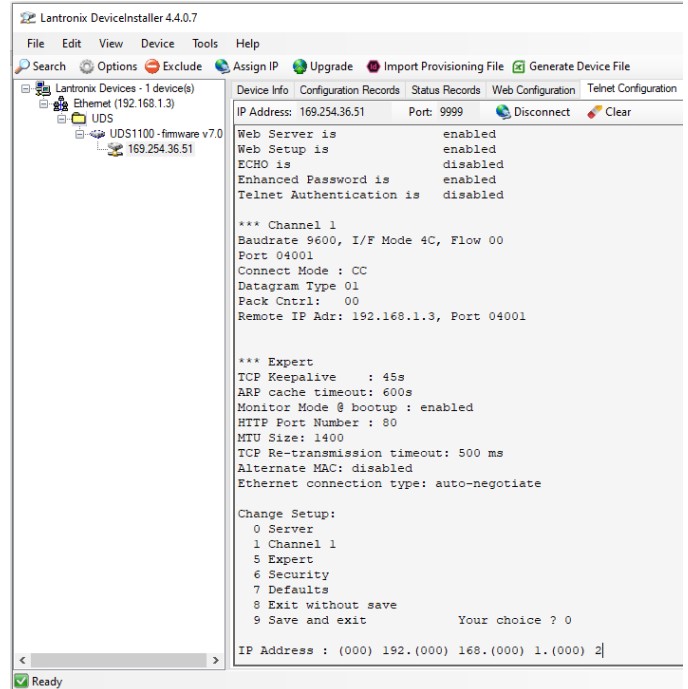

14. Type zero to enter setup mode

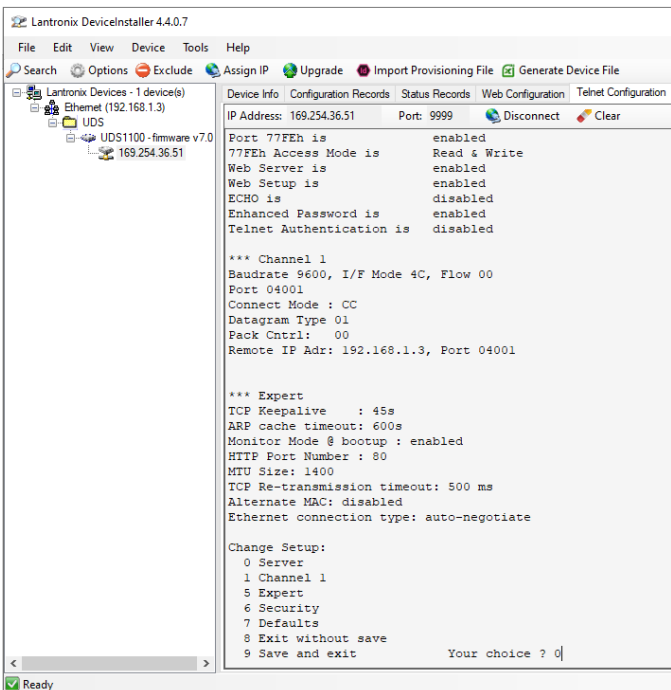

16. Type (Y) to set the gateway address for the Lantronix UDS 1100

17. Enter the gateway address and type (.) to separate each octet then press enter after last octet.

18. Use the Chart to determine Netmask. Enter 8, 16 or 24. Then press enter.

Netmask Chart

- Class A = 24 (255.0.0.0)
- Class B = 16 (255.255.0.0)
- Class C = 8 (255.255.255.0)

19. Set the DNS or if not applicable press enter.

20. If you wish to change the Telnet/ Web manager Password Type Y and press enter. Enter New Password

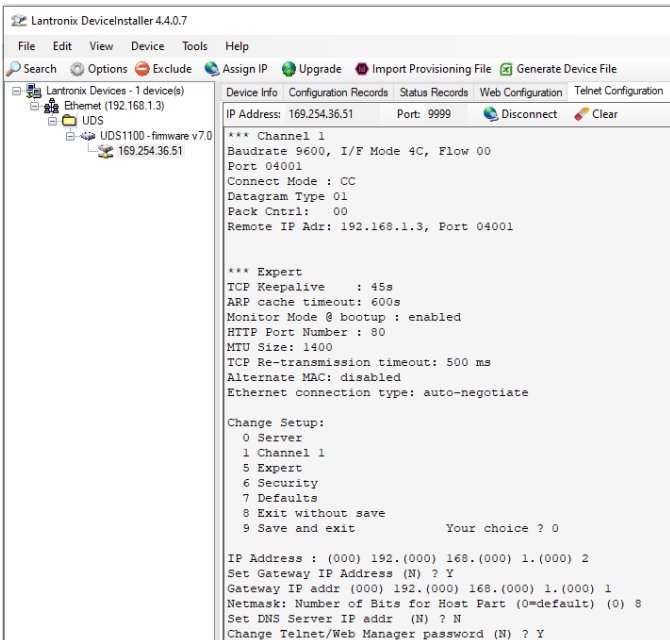

22. Connect to the UDS 1100 and enter setup mode and Type 1 to choose channel 1 options

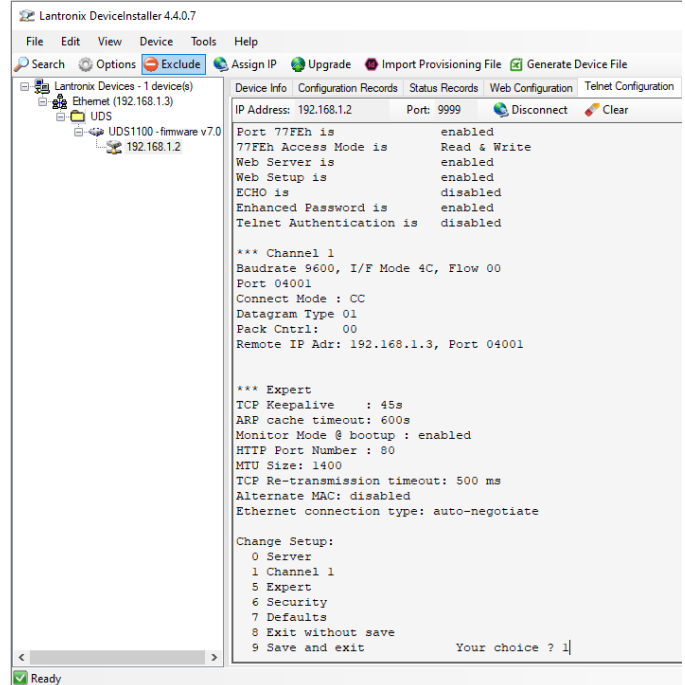

21. Type 9 and enter to save and exit settings.

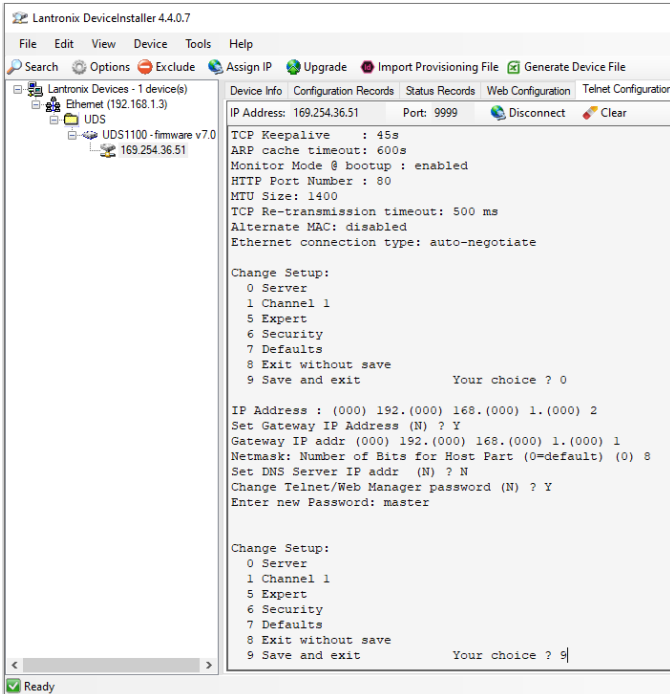

23. Type Y or Press Enter to choose Baud rate 9600.

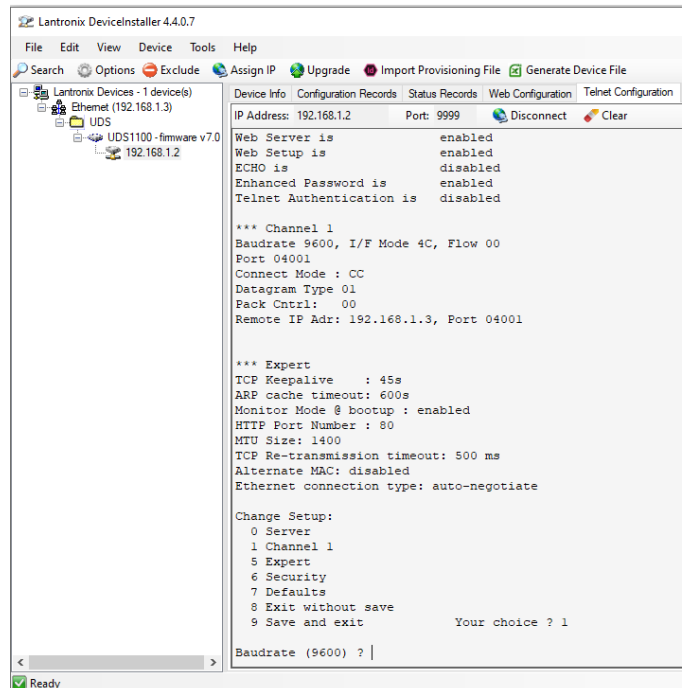

24. Set I/F Mode. RS-232=4C. RS485=4D

25. Press Enter to accept Flow Control 00

26. Enter TX port Number from the Comm Port in Database

27. Change connection mode to CC

28. Change Datagram type to =01

29. Send Broadcast =N

30. Remote IP Address= Comm Server Ip Address.

31. Type in Remote Port # which matches what is in WinDSX Database

32. Press Enter to accept the remaining defaults

33. Press 9 to Save and Exit. Connect the unit to the controller.

Master Controller Communications

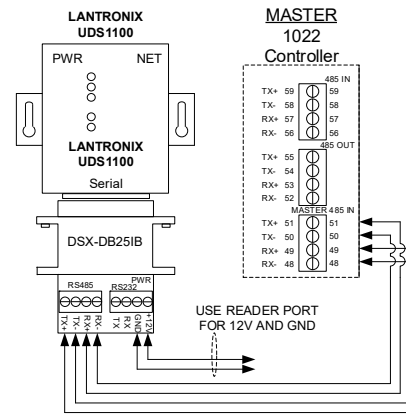
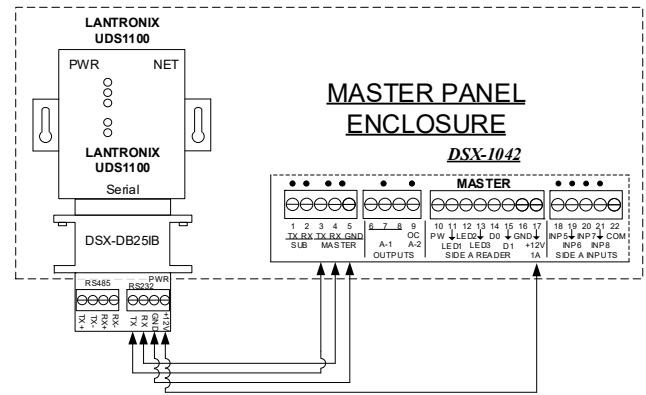

Sub Controller Communications

