



DSX Access Control

Microsoft Access™ and SQL Server™ Editions

Feature Rich

DSX is a robust access control and system monitoring application that harnesses the power of the Windows™ desktop and server operating systems. Below is a partial list of standard features.

- Mobile Command Android™/iOS™
- Point Monitoring
- Photo ID Badging
- Time and Attendance
- DVR/NVR Integration
- AES256 Comm Encryption
- Access Level History Report
- Email/Text Alarm Notification
- HazMat/Emergency Lockdown - Mobile Activated
- Redundant Hot Swap Comm Servers
- FIPS/TWIC/CAC card compatibility
- Integrated Lockset Management
- External Card Holder Management API
- Alarm Maps
- Elevator Control - braXos
- Site License - No Charge for additional Client Workstations.
- System Growth - No Charge for additional Cards or Doors.
- Support Contract - Available
- 24 Hour Emergency Support - for DSX Dealers with No Annual Fee.

Scalable Software

DSX is scalable and able to grow with your needs. Systems can grow from a single PC to multiple PCs. There are two editions of Software. DSX comes standard with a Microsoft Access database engine for small systems. DSX-SQL is designed for medium to enterprise size solutions using Microsoft SQL Server as the database engine. Microsoft SQL Server is user supplied. Both editions of DSX have similar features and capabilities.

Mobile Command

DSX Mobile Command brings the power of the DSX Workstation program to the convenience of a Smart Phone. This Smart Phone application enhances the daily operation of the DSX System. The Mobile Command feature allows the manual locking/unlocking of doors, arming/bypassing of alarm points and the monitoring of system events performed on the go from a mobile but secure application.

Global functions such as Incident Response and even repetitive chores such as momentarily unlocking a door or turning lights on and off can be programmed into Command Keys for easy activation.

An Administrator can lockdown any school in the district or every school from one Command Key. Each building or an entire campus can be controlled through this Smart Phone application using WiFi or mobile cell service.





DSX Access Control

Microsoft Access™ and SQL Server™ Editions

Management Reports

There are two new Management Reports that provide valuable data. These reports do not require In and Out Readers. **Daily Unused Cards** is a report of Active Cards that have not been used in X Hours. This can be used to find out "Who Is Not Here" at any time during the day. The report is presented by Location and sorted by Company. The Card Holders rendered by the report are listed with their last use. **Most Recent Card Use** is a "Last Use" report that shows all Active Card Holders and the last place they used their card. The report is presented by Location and sorted by Company.

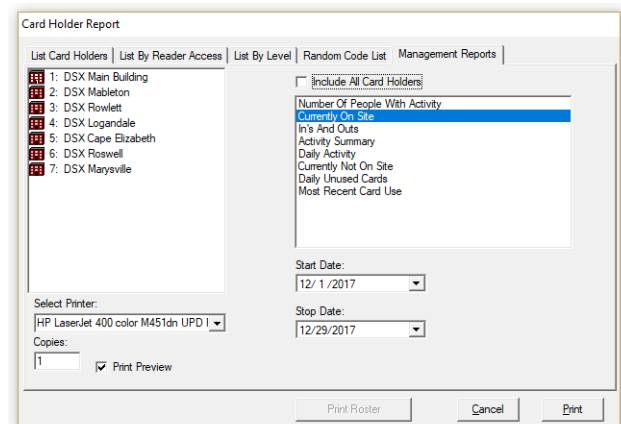

Special Applications

DSX has strong linking capabilities that allow for any card, input or output in a location to link (interlock) with any other input, output, or time zone in that location. These linking applications are simply programmed under the Hardware Tab and require no additional equipment or services.

Complex Applications include:

- Snow Days/First Man In/Man Trap
- Manager First/Two Man Rule
- Time Zone/Access Level Control
- Virtual Outputs/Clean Up Timers
- Lock- Bell Schedules/Emergency Lockdown
- Handicap Doors/Incident Response

New User Interface

The new User Interface of DSX has an organized and simplified approach to database management. Tabs at the top of the screen show the different categories of data and function. Select the tab of interest and you will see icons for the different items in that collection. A simple click on the data in the list window shows you the commands allowed by your password. This application has the capabilities of prior versions with an Enhanced User Interface.

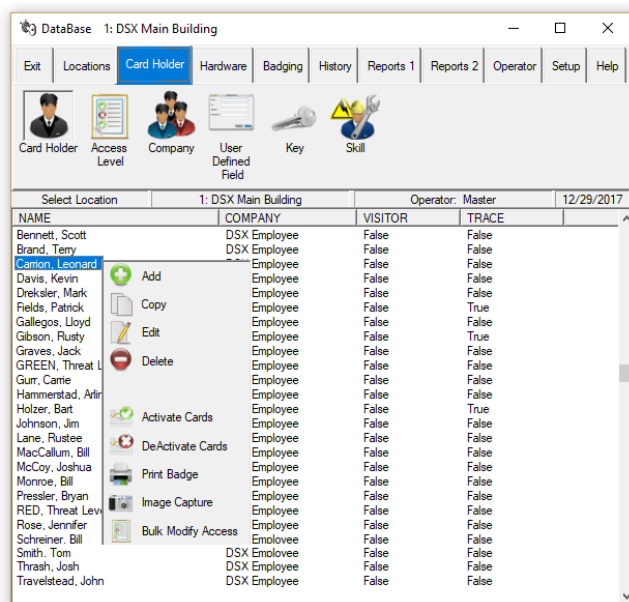

DataBase Program with Enhanced User Interface

System Security

Password protection allows for operator specific capabilities to be executed at each workstation depending on the profile assigned to the operator. AES-256 Encryption is used to secure and safeguard the passwords. AD authentication can be used to enforce password complexity and the frequency the passwords must be changed.



DSX Access Control

Microsoft Access™ and SQL Server™ Editions

Graphic Alarm and Control Maps

Graphic maps display the true real time status of assigned inputs and outputs. Maps also allow the operator to perform manual overrides of the inputs, outputs and override groups in real time.

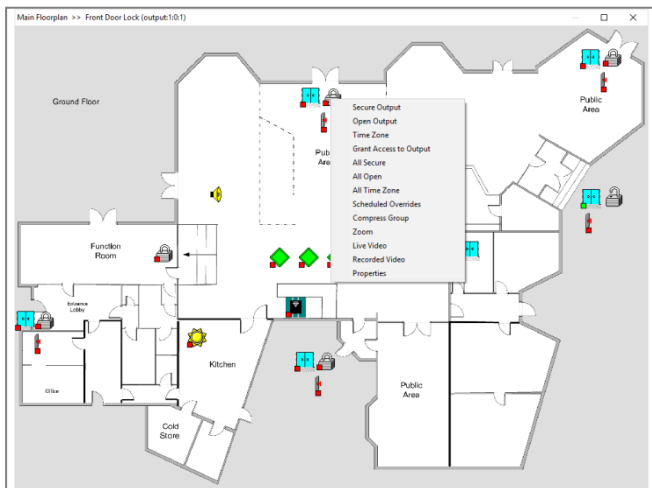

Graphic Map showing Real Time Status Icons

Video Integration

DSX can integrate with over 20 different DVR/NVR systems and IP Cameras. This integration allows stored and live video from the DVR to be accessed within the DSX software. All video is transmitted across a network connection. Remote Viewing Interface features vary based on make and model of DVR/NVR system. Check our website to see compatibilities.

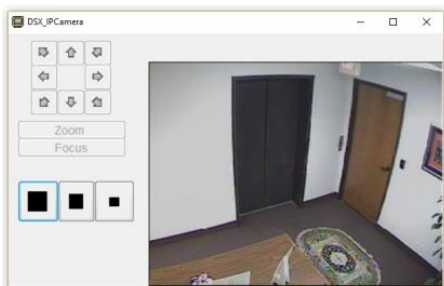

DVR Viewing Interface

History Report Generation

Custom History Reports can be defined choosing any combination of locations, doors, events, and cardholders providing as general or specific a report as needed. The reports can be previewed before printing and can be sent to a local printer or any printer on the network. Report configurations can be saved and run at any time. History reports can be preconfigured and automatically run up to twice a day each day of the week and even Emailed from the workstation they were created on. Numerous custom reports can be saved.

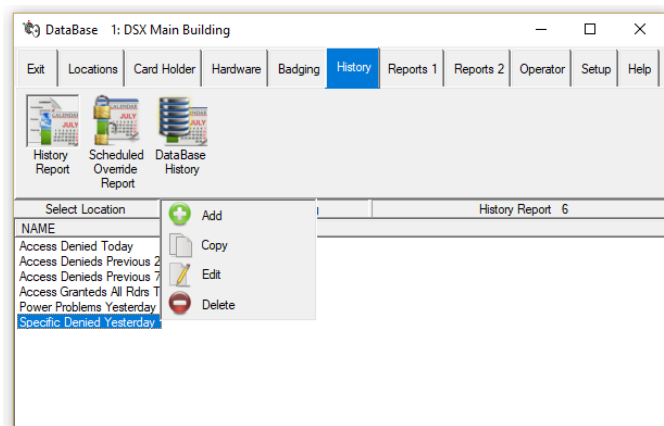

History Tab of DataBase

Scheduled Override Report shows all scheduled overrides past, present and future and if they were completed.

DataBase History is a simple method of seeing what has changed in the database, when and by whom.

PC Requirements

PC Hardware Requirements can be found on the DSX Website under products and software



DSX Access Control

Microsoft Access™ and SQL Server™ Editions

Photo ID Badging

Badging is an integral compliment of all versions of DSX. The DSX system can produce photo ID badges for employees and visitors. The system allows the user to create badge backgrounds (templates) on which digital images and card holder data is imposed when the card is printed. This exceptional feature that comes standard, for no additional charge, allows photos to be imported or captured out of a live feed from a high-resolution USB connected Camera with a remote control.

Badge templates are created using drag and drop tools with new features such as transparent backgrounds, image ghosting, text centering, text shrink to fit, right alignment, bring to front - send to back layering and rotation to any degree. The ability to create unlimited badge templates allows for all departments and user groups to have unique badges. Single or two-sided, color or monochrome, badges can be printed one at a time or in a batch mode. A print preview feature displays the assembled badge prior to printing with some last-minute adjustments available.

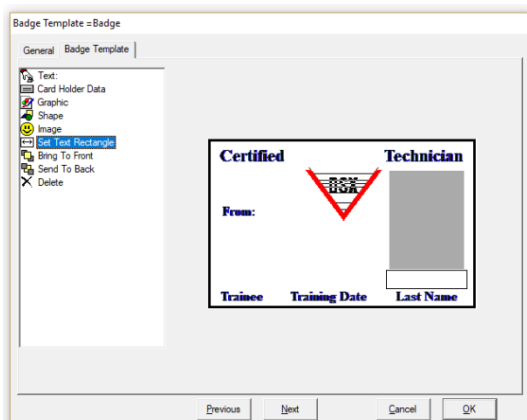

DSX Badge System Features:

- Digital Camera Pan and Tilt
- Batch Card Printing
- Image/Signature Importing
- Live Image Capture - USB Webcam
- No Features Key Required
- Transparent Backgrounds
- Multiple Images for each Person
- Image Cropping and Editing/Auto Image Editing
- Rotate Text and Bar Codes
- Encode Magstripe Track 1, 2, 3 w/equipped printer
- Generates 3 of 9, 2 of 5, 43 and 128 barcodes
- Single Sided/Double Sided Badges
- CR-80 to CR-100 Card
- Color and/or Black and White Badges
- Text Centering / Shrink to Fit text and data fields
- Right Alignment/Text Underlining
- Font and Text Color selection for each printed field
- Image Ghosting
- Bring to Front/Send to Back Layering

Camera Specifications:

- Motorized pan, tilt and zoom
- USB video class (UVC) supported applications
- Full HD 1080p
- Camera and remote control
- 10-foot range remote control
- Pan, tilt and zoom
- Carl Zeiss Optics with 9-point auto focus
- 78-degree field of view
- 180-degree pan, 55-degree tilt
- USB 2.0 compliant
- 8-foot USB cable
- 8-foot universal power adapter
- 9-inch extender stem for elevation

Printers:

DSX prints to any Windows™ compatible direct card printer such as HID and Zebra.



DSX Access Control

Microsoft Access™ and SQL Server™ Editions

DSX Software Specifications and Features:

32,000 Locations
128 Doors/Readers per location
50,000 Access Codes per location
32,000 Time Zones with 3 Holiday overrides each
32,000 Access Levels
32,000 Inputs/32,000 Outputs
32,000 Companies
32,000 Holidays
99 User Defined Fields
32,000 System Operators and 32,000 Profiles
32,000 ASCII Output Messages
999 Operator Comments
32,000 Graphic Alarm Maps
32,000 Custom Action Messages
Import Graphic Alarm Maps of 21 file types
265 + Card formats
FIPS/TWIC Card Compatibility up to 17 digits
Integral Photo ID Badging
Time and Attendance
Guard Tour/Visitor Management
DVR/NVR Integration
Auto Incremental Downloads (changes only)
Floor Select Elevator Control and Reporting
High Level Elevator Control with BraXos
After Hours HVAC Zone Control
Global Input/Output Linking
Global Code to Input/Output Linking
4 Zone Anti-Passback w/Hard, Soft and Timed
Integral Database Backup System - Access only
Integral Custom Report Generator w/Previewing
Schedule Automatic History Reports/Email SMTP
"Who Is In" Input/Mobile App Activated via Email
Card Holder "Photo Roster" Report
Code Tracing - Reader and User selectable
Regional Time Zone aware

Operator Audit Trail
Fail Safe or Fail Secure Relay Action
Icons for Input Normal/Abnormal state
Icons for Output On/Off state
TCP/IP Communications, USB, Dial-up Modem
Limit Number of Card Uses 1-10,000
Card Disable Reader
Multiple De-activate Dates for Cards
Threat Level Management
Mobile - Smart Phone Application
Auto/Manual Image Recall
Workstation Event Filtering
Global Access Level Manager
Unlimited Access Levels Per Card Holder
Date Controlled Temporary Access Levels
Card Use It or Lose It - Automatic Deactivation
Precision Start Times/Dates for Card Activation
Precision Stop Times/Dates for Card De-activation
Card Holder Biometric Enrollment Export
Embedded Hot Links in Action Messages
Scheduled Overrides w/Multiple Dates per
Time Zones controlled with Linking Logic
Hot-Swap Backup Communications Server - SQL
Hidden & Predefined User Defined Fields
Alarm Email Notification/Text Messaging
Comm Server (CS.exe) runs as a Service
Bulk modification to Card Holder Access Levels
AES Encryption from Comm Server to Controllers
AES Encryption from Comm Server to Workstations
AES Encryption for DSX Passwords
AD Integration for Operator Logon
Startup Map (always displayed)
Custom Map Sizes

DSX-L85 Software & Integrated Locksets:

Schlage - AD Series Wireless/Hardwired Locksets
Schlage - NDE and LE Wireless Locksets
DSX-L85 Supports LAN and USB communications to
Locksets. Lockset Features Supported - Standard,
Curfew Classroom/Storeroom, Office, Privacy and
Apartment.



DSX-1022

Intelligent Two Door Controller



- **8 Supervised Programmable Inputs**
- **4 Fused Relay Outputs**
- **TCP/IP Communications**
- **260+ Card/Keypad Formats+ CAC/FIPS/TWIC**
- **Non-Volatile Memory available**
- **512K RAM/512K Flash ROM**
- **UL 294/UL 1076**



General Information

The DSX-1022 is an independent processing, two door intelligent controller designed to be a cost-effective building block of the DSX hardware platform that allows expansion in a scalable manner. Up to 2 doors can be controlled from 1 enclosure allowing it to be strategically deployed where a few number of readers are required such as parking garages, gates and other remote situations. This newly designed controller has several new features such as fuses in line with the common terminals on all four relay outputs. Battery Test and Load Shed are also new features incorporated into the panel to protect the panel and its backup battery.

Controller Architecture

The DSX-1022 Intelligent Controller (panel) is designed as a unitized (processor and I/O board combined) controller with small space requirements that accommodates two discreet reader/keypad-controlled doors. The DSX-1022 can be used in conjunction with all other DSX Controllers as a Master or Sub in the Controller Network. The first Controller of each location is designated as the Master which is responsible for communications to the PC and other controllers.

The unitized DSX-1022 controller contains an RDC186 processor, RAM, ROM, power supply and removable field wiring terminals. Each DSX-1022 operates as a fully distributed processing control panel that retains all data necessary for system operation in its own RAM.

Each DSX-1022 checks its database to make decisions about access control, alarm monitoring and time zone changes. The DSX-1022 has an integral real-time clock and calendar which allows Time Zone control with Holiday overrides for Inputs, Outputs and Cards even when communication to the PC or other Controllers is not available.

Reader Technologies

The DSX-1022 is compatible with Proximity, Bar Code, Magnetic Stripe, Biometrics and Smart Card readers. Any combination of reader technologies may be used in the same system. A keypad may be added to most readers to create a Card and/or PIN controlled entry point. The DSX-1022 is compatible with over 265 different card readers/keypads and card formats which make it the perfect panel for retrofits.

Memory

The DSX-1022 has a standard configuration of 512K of Flash ROM and 512K of RAM. The RAM memory allocation is dynamic between database and event storage and set for optimum use by the Host PC according to data entered. Can be ordered with Non-Volatile Memory or added later.

Inputs

The DSX-1022 has 8 EOL supervised Inputs capable of two, three and four state point monitoring with status LEDs. The armed status of each Input can be controlled by up to 4 Time Zones, I/O & Card Linking and manually from the PC. Two Inputs are designated as Door Position Inputs and two for Exit Request. The remaining four inputs are for point monitoring.

Outputs

The DSX-1022 has six Outputs. Two Outputs (output 1s) are the Form-C, fused, relay outputs to control the locks for the reader-controlled doors. Two Outputs (output 2s) are also Form-C, fused, relay outputs that are programmed and used in the same ways as all other outputs. All Relay Outputs have fuses in series with the Common terminal. Two Pre-Warn Outputs of the DSX-1022 are used to indicate the controlled doors are being held open and about to go into alarm. If the door is locked, armed and opened, the output pulses low starting at 1/3 of the door open too long time and changes to a steady low anytime the door is in alarm. These open collector outputs reset automatically when the door is closed.

Communications

The DSX-1022 Intelligent Controller can communicate with the Comm Server via TCP/IP, USB, and dial-up modem.

TCP/IP LAN Communications can be utilized from the DSX Comm Server PC to a Master Controller. The DSX Software without the use of any additional Hardware or Software will redirect what would typically be serial port communications to a TCP/IP address. A DSX-LAN serial device at the Master Controller receives the communications over the LAN and converts it to RS-232/RS-485 for the Master Controller. The result is real time communications similar to that of a direct serial port connection.

Direct Connect Communications to the PC from the Master 1022 Controller is performed with the use of the DSX-USB module which connects to the USB port of the PC and provides the RS-485 output that connects to the panel. The RS-485 communications from the DSX-USB to the Master utilizes two twisted pair cable for the data. The RS-485 output of the DSX-USB will support up to 4000 feet of cable distance. The controller communicates with the PC at a default baud rate of 9600. If the communications signal arrives at the Master as RS-485 in an asynchronous, full duplex mode, operating at 9600 baud, the method of communication in between can be just about any mode of transport such as Direct Wire, T1, Lease Line, or Fiber Optics.

Dial-Up Modem Communications from the DSX-1022 Master Controller to the PC utilizes a DSX-Modem at the Controller and a DSX-Modem at the PC. At the DSX-1022 Master, the RS-485 Master Communications Port connects to the RS-485 port of a DSX-Modem. (Older modems required an MCI module to convert the RS-485 of the 1022 to RS-232 for the modem.) The Modem derives power from the 12VDC output of the DSX-1022 panel. The Controller will auto-dial to the PC all alarm and supervisory conditions. The controller can also be programmed to dial the PC when its event buffer is 80% full.

Panel to Panel Communications is a true point to point, regenerative, RS-485, 4-wire, communications method. This allows the panel-to-panel network communications to be regenerated at each controller providing up to 4000 feet of distance between controllers over two twisted pair cable. Panel to Panel communications can be configured in a series loop, star configuration or both. Star configurations require a DSX-1035 Quadraplexor.

DSX-1022 Specifications

Size

Cabinet 15.5" W x 13.5" H x 6.0" D
DSX-1022 10.5" W x 7.5" H x 1.5" D

Weight

Cabinet 11.00 lb.
DSX-1022 1.60 lb.
Package Total 12.60 lb.

Finish

Black Powder Coat on Enclosure and Black Enamel on Shield

Temperature/Humidity

Operating 32 to 131F / 0 to 95% relative -Storage -35 to 150 F

Supply Voltage

Panel Voltage 16.5 VAC 40VA for UL 1076 use 2 transformers
Power Requirements 33 Watts (112.6 BTU)
Panel Current Draw 540 ma
UL Listed or CSA Certified Class II Transformer Required.

Output Voltage

Panel Output 12VDC 1A - Fused
Panel Output 5VDC 1/2A - Fused

Inputs

EOL Supervised 8
UL Installations require a Tamper Switch to be connected to an Input programmed with a 24hr Time Zone.

Outputs

Form C Relays (1-2) 4 fused at 1A
Relay Ratings 5 AMP 30 VDC
LED Outputs 6 - 3 per reader - open collector 100ma
Pre-Alarm Outputs 2 - 1 per door - open collector 100ma

Access Controlled Entry Points

Card Reader or Keypad 2 Any combination of card readers, keypads, or card and keypad-controlled entry points may be used. Over 265 types available including FIPS/TWIC cards up to 17 digits.

Battery Charging Output

Trickle Charge 13.5 VDC 500ma Fused
Standby Time 3.3 hours under maximum load.
For UL Installations, battery must be Powersonic PS-1270, Interstate PC -1270, or SBS S-1272. For UL1076 use two batteries.

Communication Ports

RS-485 In (2) 1 for Master to PC, 1 From Sub
RS-485 Out 1 To Subsequent Subs

Processor RDC186 20Mhz

RAM Memory Standard 512K

Non-Volatile Memory can be added to any existing DSX-1022 Controller. Part number is DSX-1040NV. Controllers can also be ordered with non-volatile memory. See Price List for details.

Warranty

Limited 2 Years



DSX-1048

Intelligent Controllers



- Scalable Architecture from 2-8 doors
- UL 294/UL 1076
- 260+ Card/Keypad Formats+ CAC/FIPS/TWIC
- Real Time Processing and Communications
- Integrated Power Supply and Distribution
- Non-Volatile Memory available



General Information

The DSX-1048PKG Intelligent Controller is an independent processing 8 door package designed to be a cost-effective building block platform that allows expansion in a scalable manner. Up to 8 doors can be controlled from 1 enclosure for an efficient space saving package. The controllers are strategically placed throughout the customer location connected with a two twisted pair cable. Each DSX-1048 operates as a fully intelligent and independent controller that retains all data necessary for system operation in its own RAM. With its integral real-time Clock and Calendar, it performs Time Zone control with Holiday overrides for inputs, outputs and cards even when communication to the PC or other controllers is not available. The DSX-1048 carries a Limited 2 Year Warranty.

Controller Architecture

The DSX-1048 Intelligent Controller may be used in conjunction with all other DSX Controllers as a Master or Sub in the controller network. Any controller may be designated as a Master or Sub controller. The Master or Sub mode of operation is determined by the panels dip switch settings. The first panel of each location is designated as the Master while all others would be considered Subs. The Master is responsible for communications to the PC and to the Sub panels. Up to 16 - DSX-1048PKG Intelligent Controllers can be used in a single Location providing for 128 readers. Multiple Locations can be grouped for systems that require more than 128 readers/keypads.

Each DSX-1048PKG includes a DSX-1040E Enclosure, a DSX-1040CDM Communication Distribution Module and 4 DSX-1042 Intelligent Controllers. Each DSX-1048 provides 8 Reader Ports, 32 Inputs and 16 Outputs. Each DSX-1042 has a 12volt fused power output for its Card Readers and Keypads. The DSX-1042 contains an RDC186 processor, 512K of RAM, 512K of Flash ROM and a Real Time Clock. The DSX-1048 allows all door and field wiring connections to be made via removable terminal blocks. The DSX-1040CDM receives RS-485 communications from a possible previous panel and regenerates the 4 wire-RS485 to the next DSX-1048PKG. The DSX-1040CDM also distributes Sub Controller communication to Sub panels within the same enclosure.

The DSX-1040CDM receives its power from a DSX-1040PDP (Power Distribution Panel) is used in conjunction with the DSX-1048PKG Intelligent Controller Package. The DSX-1040PDP houses the controller and lock power supplies, backup batteries and fused power distribution module.

System Power

Each Controller in the DSX-1048PKG is powered from an individually fused 12volt output from the DSX-1040CDM distribution module located in the same enclosure. The module also provides 5volt power for those Readers and/or Keypads that require it. The DSX-1040CDM receives power from the DSX-1040PDP Power Distribution Panel.

The DSX-1040PDP houses the controller and lock power supplies, backup batteries and fused power distribution module. The DSX-1040PDP is comprised of a DSX-1040PE Enclosure, an RWS-150 15V power supply for the controllers, an RWS-150-[15] or [27] for either 12V or 24V locks and a DSX-1040PDM Power Distribution Module. The DSX-1040PDM performs several critical functions. First, it takes the 15V power from the SWS-150 and provides two 3.5A Class II, Power Limited, fused outputs to power the DSX-1040CDM which distributes the power to the DSX-1042 Controllers in the DSX-1048PKG. It provides a 12V Battery Charging Circuit to charge backup batteries for the controllers. It also provides a charging circuit for the optional batteries used to backup the 12- or 24-volt lock power from the RWS-150 lock power supply. The Power Distribution Module has 3 N.C. Relay Outputs, two to signal Loss of AC (one for lock power and one for controller power) and one to signal Low Battery. These Outputs can be connected to spare Inputs in the DSX-1048PKG. The module also has a Battery Test Input. This Input when activated shuts off the charging circuit and load tests the battery for 1 minute. This Input can be connected to a spare Output in the DSX-1048PKG and programmed by time zone to occur when desired. The DSX-1040PDM routes Lock Power through individual fuses for each of the 8 Class II, Power Limited, outputs. The module also has an input for a Fire Override relay contact to break Lock Power and has a Fire Override Output to connect to the next 1040PDM. All Outputs are Class II, Power Limited.

Reader Technologies

The DSX-1048 is compatible with Proximity, Bar Code, Magnetic Stripe, Biometric and Smart Card readers. Any combination of reader technologies may be used in the same system. A keypad may be added to most readers to create a card and/or PIN controlled entry point. The DSX-1048 is compatible with over 260+ different card readers/keypads and card formats which make it the perfect panel for retrofits. Conversion modules exist for some types of other manufacturers proprietary card readers. The panel is compatible with two wire Wiegand and clock and data outputs without the use of any modules. Each reader port has 3 LED open collector outputs for Door Secure, Door Open and Access Denied/Keypad PIN Entry. This will accommodate almost any reader and LED configuration. It is possible to connect the sounder control line of most card readers directly to the Pre-Warn output for door held open annunciation.

Memory

Each Controller has a standard configuration of 512K of Flash ROM and 512K of RAM. The RAM memory allocation is dynamic between database and event storage and set for optimum use by the Host PC according to data entered for that location. Flash ROM allows for the Controllers' operating system to be upgraded without the changing of chips

(EPROMS). Having 512K of RAM eliminates the necessity of increasing the memory in controllers as the system grows. When the Controller is in service the amount of RAM and the version of ROM can be viewed from the DSX communications software. Non-Volatile Memory can be added to any existing DSX-1042 Controller. The Part number is DSX-1040PNV. Controllers can also be ordered with non-volatile memory.

Inputs

The DSX-1048PKG has 32 EOL supervised Inputs capable of two, three and four state point monitoring with trouble reports. The armed status of each Input can be controlled by up to 4 Time Zones, I/O & Card Linking and Manually from the PC. Eight Inputs are designated as Door Position and eight Inputs are designated as Exit Request Inputs for the reader-controlled doors. The remaining sixteen Inputs are then left for additional monitoring points.

Outputs

The DSX-1048PKG has 16 Programmable Outputs. Eight Outputs are Form-C, 5 Amp rated relays used to control the locks for the reader-controlled doors. Eight Outputs are the open collector type, both have an LED for status and are fully programmable. In addition to the 16 programmable Outputs there are 8 Pre-Warn Outputs (1 for each door) that are used to indicate the reader-controlled doors are being held open and are about to go into alarm. Once the door is opened the Output begins pulsing low starting at 1/3 of the door open too long time and changes to a steady low anytime the door is in alarm. These open collector (switched negative) outputs reset automatically when the door is closed.

TCP/IP LAN Communications

The DSX-1048PKG Intelligent Controller can communicate with the DSX Communications Server via TCP/IP LAN communications, USB to Serial connection and Dial-Up Phone Modem. TCP/IP LAN Communications can be performed from the DSX Comm Server PC to a Master Controller. The DSX Software without the use of any additional Hardware or Software will direct communications to a TCP/IP address. A DSX-LAN serial device at the Master Controller receives the communications over the LAN from the DSX PC and converts it to RS-232 for the Master Controller. The result is real time communications.

Direct Connect Communications from the PC to the Master 1042 Controller can be performed with a DSX-USB module which connects to the USB port of the PC and provides the RS-232 output that connects to the Controller. The RS-485 output of the DSX-USB can be used if the Master Controller is more than 50 feet away by placing a DSX-MCI module at the Controller to convert the RS-485 output of the USB back to RS-232 for termination. RS-485 from the DSX-USB will support up to 4000 feet over two twisted pair cable.

The controller communicates with the PC at a default baud rate of 9600. As long as the communications signal arrives at the Master as RS-232 in an asynchronous, full duplex mode, operating at 9600 baud, the method of communication in between can be just about any mode of transport such as Direct Wire, T1, Lease Line or Fiber Optics.

Enclosure to Enclosure Communications is handled at each DSX-1048 by a DSX-1040CDM (communications distribution module) using true point to point, regenerative, RS-485, 4-wire communications. This module has 2 RS-485 ports for in and out 4 wire communications to other Enclosures. The Controller network communications is regenerated at each DSX-1040CDM allowing up to 4000 feet of distance between Enclosures over two twisted pair cable. The DSX-1040CDM has 2 RS-232 Communication Ports. One is used to connect to the Master Controller and is only used in the DSX-1048PKG Enclosure where the Master Controller resides. The other RS-232 port connects to the RS-232 port of each Sub Controller in that same enclosure. Enclosure to Enclosure communications is connected in a series loop configuration unless a DSX-1035 Quadraplexor is used for Star wiring.

IP Sub Communications can be achieved with the use of a DSX-IP-HUB. The DSX-IP-HUB is a module that connects to the Master Controller and to the Network which allows Sub Controller Communication to be routed via IP through the network to standard DSX-LAN modules connected to Sub Controllers or clusters of Sub Controllers.

DataBase Downloads

The Controllers utilize a synchronized database that is maintained with the incremental and automatic or scheduled downloading of changes only. This intelligent, independent processing increases the speed of the panel's actions and reactions, providing more stability and security to the overall system. The Controllers are downloaded with all parameters the first time they are brought on-line. Once the initial full download occurs all database changes such as adding and deleting of card holders are sent to the Controllers by way of incremental downloads. The Controllers' transaction buffer adjusts its size to utilize any RAM not allocated for data.

Diagnostic, Supervisory and Status LEDs

The DSX-1048 has 88 diagnostic LEDs to indicate panel status. Thirty-two are for Input Status and sixteen are for Output status. The rest are for Communications, Fuse Status and Processor Status.

DSX-1048 Specifications

Size

DSX-1040E Cabinet 15.5" W x 22.5" H x 6" D
 DSX-1040CDM 11" W x 4.5" H x 1.5" D
 DSX-1042 11" W x 4.5" H x 1.5" D

Weight

DSX-1040E Cabinet 19.2 lb.
 DSX-1040CDM 1.0 lb.
 DSX-1042 1.2 lb.
 DSX-1048 - Total 25.0 lb.

Finish

Black Powder Coat with White Silkscreen on Enclosure

Enclosure / Conduit Knockouts

Concentric knockouts in Top, Bottom and Sides
 Knockouts accommodate 1/2, 3/4, 1, 1 1/2 inch conduit
 Nema Type 1 equivalent enclosure with lift-off hinged door, lock/key and tamper switch

Temperature

Operating 32 to 131 F
 Storage -35 to 150 F

Humidity

Operating 0 to 95%, relative

Power Requirements

DSX-1042 13.5 VDC @ 300ma from 1040CDM
 DSX-1040CDM 13.5 VDC @ 150ma from 1040PDP
 Total Maximum Current 13.5 VDC @7.0A

Output Voltage

Panel outputs provide a regulated, fused, DC voltage.
 DSX-1042 9-13.5VDC - 12VDC nominal - 1A Fused
 DSX-1040CDM 9-13.5VDC - 12VDC nominal - 1.5A Fused
 DSX-1040CDM 5VDC - .5A Fused
 All Outputs are Class II, Power Limited

Inputs

EOL Supervised 32

16 Inputs are used for standard point monitoring.

16 Inputs are used for door position and exit request monitoring.

All Inputs support two, three and four state monitoring with five programmable circuit types.

Outputs

Form C Relays 8
 Relay Output Ratings 5 AMP - 30VDC
 Open Collector Outputs 8 - negative 100ma
 LED Outputs 24 - 3 per reader port - negative 100ma
 Pre-Alarm Outputs 8 - 1 per door - negative 100ma

Access Controlled Entry Points

Card Reader or Keypad 8
 Card and Reader Formats 260+ including CAC/FIPS/TWIC
 Any combination of card readers, keypads, or card and keypad-controlled entry points may be used.

Communication Ports

DSX-1042
 RS-232 In 1 Master to PC
 RS-232 Out 1 Panel to DSX-1040CDM
 1040CDM
 RS-232 In 1 Master to DSX-1040CDM
 RS-232 Out 1 Sub Communications
 RS-485 In 1 From previous DSX-1048 Package
 RS-485 Out 1 To subsequent DSX-1048 Packages

Processor

RDC186 20Mhz

RAM/ROM Memory

Flash ROM 512K / Standard RAM 512K

Non-Volatile Memory can be added to existing Controllers or ordered with new ones.

Warranty - Limited 2 Years

Basic Architecture

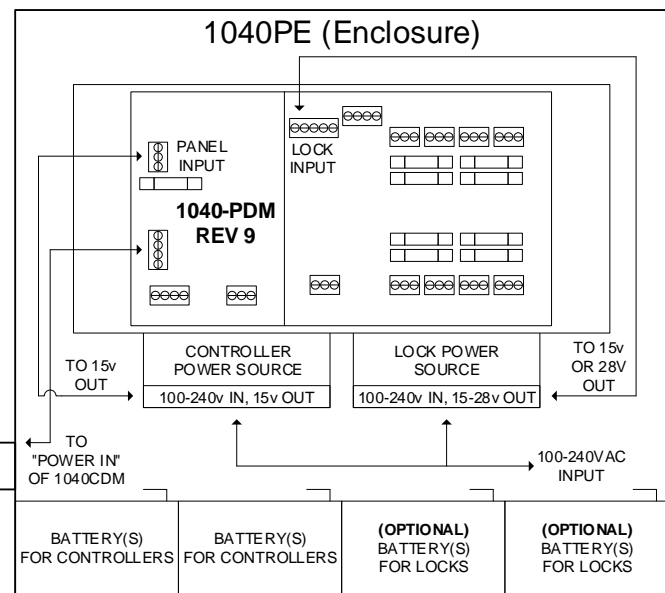
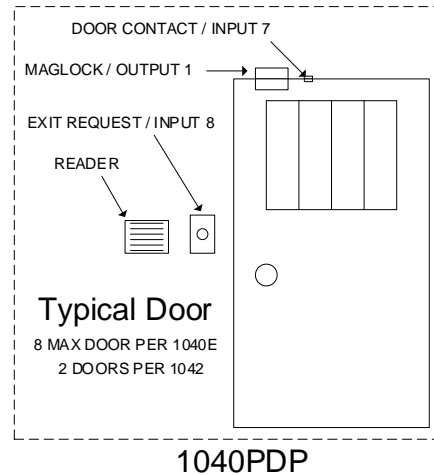
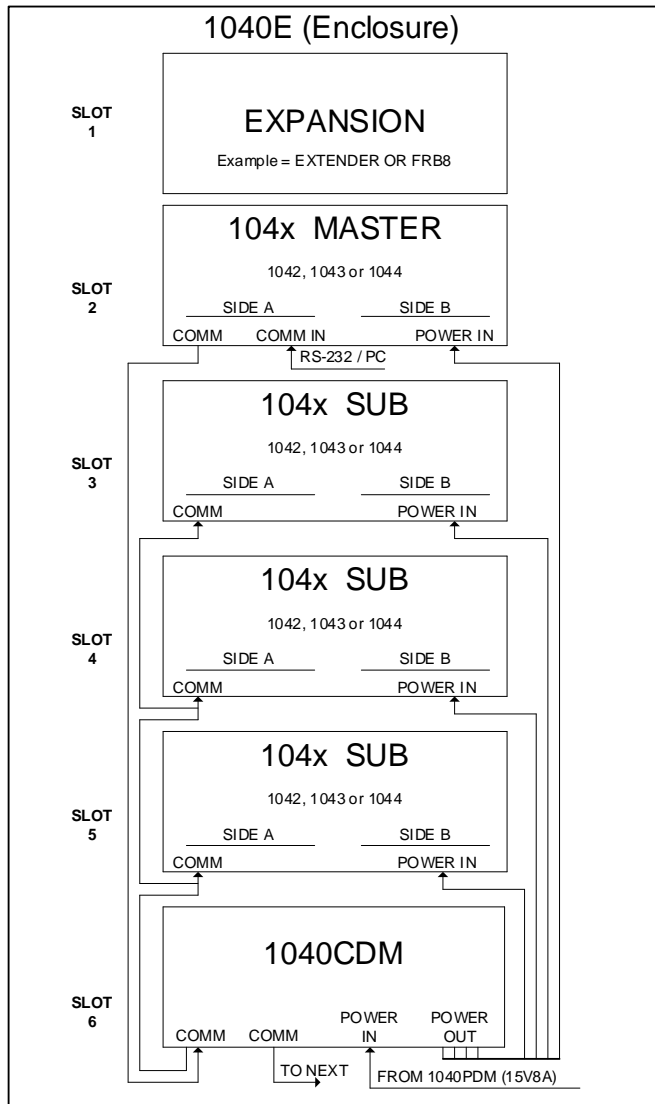

The DSX-1048PKG includes a DSX-1040E Enclosure, a DSX-1040CDM Communication Distribution Module and 4 – 1042 Intelligent Controllers. This provides 8 Reader Ports, 32 Inputs and 16 Outputs. The DSX-1048 Package comes complete with 32-1K ohm EOL Resistors, Lock & Key, Wire Ties, Tamper Switch, an External Power Indicator and a DSX-1040PDP Power Distribution Panel.

The DSX-1040CDM receives RS-485 communications from a possible previous enclosure and regenerates the 4 wire-RS485 to the next DSX-1048PKG. The DSX-1040CDM module also distributes RS-232 Sub Controller communication to the Sub panels within the same enclosure. Each DSX-1042 is powered from an individually fused 12volt output from the DSX-1040CDM Communications Distribution Module.

The DSX-1040CDM receives power from two current limited outputs on the DSX-1040PDP Power Distribution Panel.

Used in conjunction with the DSX-1048PKG is a DSX-1040PDP or Power Distribution Panel. The DSX-1040PDP houses the panel and lock power supplies, backup batteries and fused power distribution module. The DSX-1040PDP is comprised of a DSX-1040PE Enclosure, an RWS-150 15V power supply for the Controllers, an RWS-150-[15] or [27] for either 12V or 24V locks and a DSX-1040PDM. The DSX-1040PDM performs several critical functions such as supervising Power Supplies and Batteries, distributing power through fused outputs and providing battery charging circuits. All Outputs are Class II, Power Limited.



DSX-1040 PDP

Power Distribution Panel



- **12VDC/7A Power for Controllers**
- **Battery Backup for Controllers**
- **Optional Battery Backup for Locks**
- **Lock Power 12VDC-8A/24VDC-4A-8A**
- **UL 294/UL 1076**
- **AC Loss/Low Battery Supervisory Outputs**
- **All Outputs - Class II, Power Limited**
- **Fire Override Input & Output**

General Information

The DSX-1040PDP Power Distribution Panel is the supervised power plant for the DSX-1048PKG Intelligent Controller. The DSX-1040PDP houses the panel and lock power supplies and backup batteries. The DSX-1040PDP is comprised of a DSX-1040PE enclosure, an RWS-150 15VDC power supply for the controllers, an RWS-150-[15] or [27] for either 12 or 24VDC locks and a DSX-1040PDM Power Distribution Module. The DSX-1040PDP carries a Limited 2 Year Warranty.

Power Architecture

The DSX-1040PDP contains an RWS-150 Power Supply that converts 115VAC to 15VDC for Controller Power. Also present is an RWS-150 15/27 Power Supply which converts 115VAC to either 12 or 24VDC for Lock Power. Both Power Supplies feed power to the DSX-1040PDM Power Distribution Module. The DSX-1040PDM provides fused 12VDC/7A power to the DSX-1040CDM located in the DSX-1048 enclosure. The DSX-1040CDM redistributes the power through individually fused outputs to each Controller in the DSX-1048. The Controllers have 12VDC/1A fused power for Readers and Keypads.

Power Distribution Module

The DSX-1040PDM performs several critical functions. First, it takes the 15VDC power from the RWS-150 and provides two 12VDC 3.5-amp, Class II, Power Limited, Fused Outputs to



power the DSX-1040CDM which distributes the power to the DSX-1042 Controllers in the DSX-1048PKG. It provides a 12VDC Battery Charging Circuit to charge backup batteries for the Controllers. It also provides a charging circuit for the optional batteries used to backup the 12- or 24-volt lock power from the RWS-150 power supply.

The Power Distribution

Module has outputs to signal Loss of AC and Low Battery. The module also has a Battery Test Input and Load Shed capabilities. The DSX-1040PDM routes Lock Power through individual fuses for each of the 8 outputs. All Outputs are Class II, Power Limited. Each Output has a Fire Override Bypass jumper to exclude it from a Fire Override activation.

Inputs

The DSX-1040PDM has a Battery Test Input. This Input when activated shuts off the charging circuit and load tests the battery for 1 minute. This Input can be tied to a spare Output in the DSX-1048PKG Controller and programmed by Time Zone to occur when desired. The module also has connection points for a Lock Power Fire Override Relay to break Lock Power to all 8 Outputs.

Outputs

The DSX-1040PDM Power Distribution Module has 3 normally closed Relay Outputs - two to signal Loss of AC (one for panel power and one for lock power) and one to signal Low Battery. These Outputs can be connected to three spare Inputs in the DSX-1048PKG. The DSX-1040PDM routes Lock Power through individual fuses for each of the 8 Outputs with connection points for the lock wiring and for the Output relays located in the DSX-1048. There is also an output from the Lock Power Fire Override that can be connected to an input in the 1048 for monitoring or can be used to connect to the Fire Override Input on the next 1048 and 1040PDP.

Basic Architecture

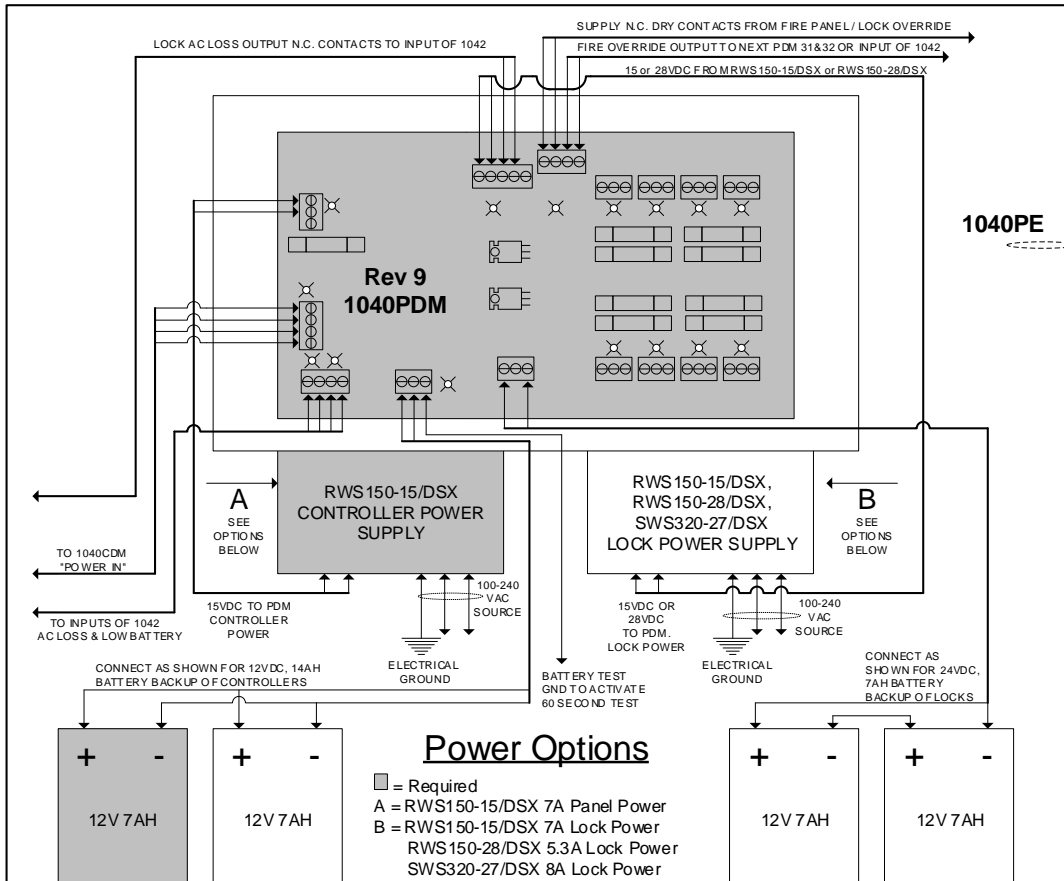

Size

DSX-1040PE Cabinet 15.5" W x 14" H x 6" D
 DSX-1040PDM 8" W x 4" H x 1.5" D
 RWS-150-15/27 3.9" W x 7.8" H x 2.0" D

Weight

DSX-1040PE Cabinet 11.00 lb
 DSX-1040PDM 1.30 lb
 RWS-150 15/27 1.60 lb

Finish

Black Powder Coat with White Silkscreen

Enclosure/Conduit Knockouts

Concentric knockouts in Top, Bottom and Sides
 Knockouts accommodate 1/2, 3/4, 1, 1 1/2 inch conduit
 Nema Type 1 equivalent enclosure with lift-off hinged door, lock/key and tamper switch

Supervisory Outputs

Low Battery 1 - N.C. Relay
 Loss of AC 2 - N.C. Relays

Warranty

Limited 2 Years

Power Input Requirements

DSX-1040PDM 15VDC/7A for Panels
 15VDC/8A or 27VDC/4 - 8A for Locks
 RWS-150 120VAC (88-264VAC) auto

Power Outputs

DSX-1040PDM 10-15VDC, 12VDC nominal 2 – 3.5A outputs
 8 - 12VDC@8A or 24VDC@4-8A for Locks
 12VDC/3A Panel Battery Charging Circuit
 12/24VDC/3A Lock Battery Charging Circuit
 RWS-150/15 15VDC 8.0A 150 Watts 511.8 BTUs
 RWS-150/27 27VDC 4.0A 150 Watts 511.8 BTUs
 SWS-320/27 27VDC 8.0A 320 Watts 1091.8 BTUs
 *All 1040PDM Outputs are Class II, Power Limited

Inputs

Battery Test Active Low from spare Output on DSX-1048
 Fire Override Connection point for N.C. relay contact to control PDM relay that enables all Lock Power

Diagnostic LEDs

The DSX-1040PDM has 17 diagnostic LEDs. There are Power On LEDs for each of the two power inputs, for Low Battery and Battery Test and for AC Loss and Fire Override. The DSX-1040PDM also has 1 LED for each of the eight fused Outputs for Lock Power.



DSX-1043

Intelligent Output Controller

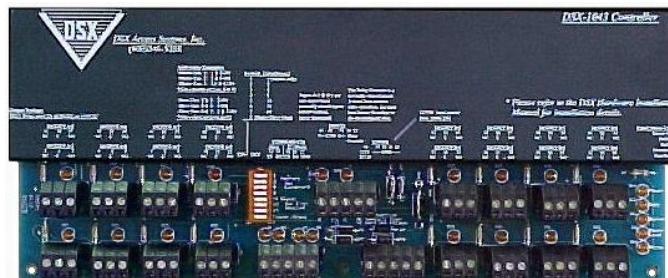

- **16 Programmable Form C Relays**
- **4 Time/Day Schedules per Output**
- **Output Control (Override) Input**
- **Two Inputs for supervision**
- **UL 294/UL 1076**
- **Flexible I/O Linking**
- **Non-Volatile Memory Available**
- **Scalable Architecture**

General Information

The DSX-1043 is an independent processing, 16 output, intelligent controller designed to be a cost-effective building block in the DSX hardware platform that allows expansion in a scalable manner. Up to 64 outputs can be controlled from 1 enclosure for an efficient space saving package. Each DSX-1043 operates as a fully intelligent and independent controller that retains all data necessary for system operation in its own RAM. With its integral real-time Clock and Calendar, it performs Time Zone control with Holiday overrides for outputs even when communication to the PC or other controllers is not available. The DSX-1043 carries a Limited 2 Year Warranty.

Controller Architecture

The DSX-1043 Intelligent Controller may be used in conjunction with all other DSX Controllers as a Master or Sub in the controller network. Any controller may be designated as a Master or Sub controller. The Master or Sub mode of operation is determined by the panel's dip switch settings. The first panel of each location is designated as the Master while all others would be considered Subs. The Master is responsible for communications to the PC and to the Sub panels. Up to 64 Controllers can be used in a single Location.



Up to four DSX-1043 controllers can be placed in a DSX-1040E Enclosure along with a DSX-1040CDM Communication Distribution Module. The controller can be placed in a 1042PKG mixed with DSX-1042 and DSX-1044 Controllers. The DSX-1043 contains an RDC186 processor, 512K of RAM, 512K of Flash ROM and a Real Time Clock. The DSX-1043 allows all door and field wiring connections to be made via removable terminal blocks. The DSX-1040CDM receives RS-485 communications from a possible previous panel and regenerates the 4 wire RS-485 to the next DSX Controller. The DSX-1040CDM also distributes RS-232 Sub Controller communication to those Sub panels located within the same enclosure.

Outputs

The DSX-1043 has 16 Programmable, Form-C, 5 Amp 30VAC/30VDC rated Relay Outputs. The on/off state of the outputs can be controlled by up to 4 Time Zones, I/O & Card Linking and Manually from the PC. The Relay Override Input requires a closure for the outputs to operate. When the Override Input is open the outputs are de-energized. All Outputs have an LED for status.

Inputs

The DSX-1043 has 2 non-supervised inputs for tamper monitoring. The armed status of each input can be controlled by up to 4 Time Zones, I/O & Card Linking and Manually from the PC.

System Power

Each DSX-1043 is powered from an individually fused 12volt output from the DSX-1040CDM distribution module located in the same DSX-1040E enclosure.



DSX-1044

Intelligent Input Controller

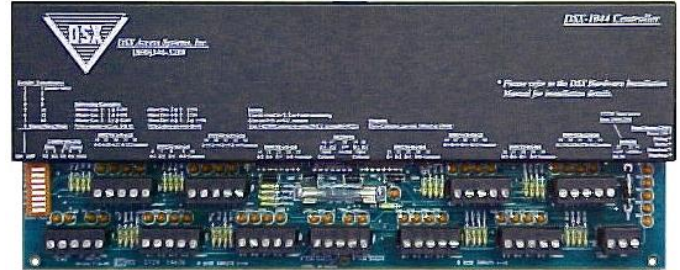

- **32 Programmable Inputs**
- **2, 3 and 4 State Monitoring**
- **4 Digital (open collector) Outputs**
- **Status LEDs for each Input**
- **UL 294/UL 1076**
- **Flexible I/O Linking**
- **Non-Volatile Memory Available**
- **Scalable Architecture**

General Information

The DSX-1044 is an independent processing, 32 input, intelligent controller designed to be a cost-effective building block in the DSX hardware platform that allows expansion in a scalable manner. Up to 128 inputs can be controlled from 1 enclosure for an efficient space saving package. Each DSX-1044 operates as a fully intelligent and independent controller that retains all data necessary for system operation in its own RAM. With its integral real-time Clock and Calendar, it performs Time Zone control with Holiday overrides for inputs even when communication to the PC or other controllers is not available. The DSX-1044 carries a Limited 2 Year Warranty.

Controller Architecture

The DSX-1044 Intelligent Controller may be used in conjunction with all other DSX Controllers as a Master or Sub in the controller network. Any controller may be designated as a Master or Sub controller. The Master or Sub mode of operation is determined by the panel's dip switch settings. The first panel of each location is designated as the Master while all others would be considered Subs. The Master is responsible for communications to the PC and to the Sub panels. Up to 64 Controllers can be used in a single Location. Up to four DSX-1044 controllers can be



placed in a DSX-1040E Enclosure along with a DSX-1040CDM Communication Distribution Module. The controller can be placed in a 1042PKG mixed with DSX-1042 and DSX-1043 Controllers. The DSX-1044 contains an RDC186 processor, 512K of RAM, 512K of Flash ROM and a Real Time Clock. The DSX-1044 allows all field wiring connections to be made via removable terminal blocks. The DSX-1040CDM receives RS-485 communications from a possible previous panel and regenerates the 4 wire RS-485 to the next DSX Controller. The DSX-1040CDM distributes RS-232 Sub Controller communication to those Sub panels located within the same enclosure.

Inputs

The DSX-1044 has 32 Programmable Inputs. The armed status of each input can be controlled by up to 4 Time Zones, I/O & Card Linking and Manually from the PC. Each input has its own status LED that is on when the input is normal. Each input individually supports 2, 3 and 4 state point monitoring.

Outputs

The DSX-1044 has 4 digital (open collector) outputs that have the same programmability and functionality as all other DSX outputs. The on/off state of each output is reflected by their status LEDs. The outputs can be controlled by up to 4 Time Zones, I/O & Card Linking and Manually from the PC.

System Power

Each DSX-1044 is powered from an individually fused 12volt output from the DSX-1040CDM distribution module located in the same DSX-1040E enclosure.

DSX-1043 Specifications

Size

DSX-1043 11" W x 4.5" H x 1.5" D

Weight

DSX-1043 1.6 lb.

Finish

Black Powder Coat with White Silkscreen on Enclosure
Black Nylon with White Silkscreen on DSX-1043

Temperature

Operating 32 to 131 F
Storage -35 to 150 F

Humidity

Operating 0 to 95%, relative

Power Requirements

DSX-1043 13.5 VDC @ 800ma from 1040CDM

Inputs

Non-Supervised - 2
Relay Override Input - 1

UL Installations require a Tamper Switch to be connected to an Input programmed with a 24hr Time Zone.

Outputs

Form-C Relays - 16
Relay Output Ratings 5 AMP 30 VDC

Communication Ports

RS-232 In 1 Master to PC
RS-232 Out 1 Panel to DSX-1040CDM

Processor

RDC186 20Mhz

RAM/ROM Memory

Flash ROM 512K
Standard RAM 512K
Non-Volatile Memory is available for new and existing controllers.

Warranty

Limited 2 Years

DSX-1044 Specifications

Size

DSX-1044 11" W x 4.5" H x 1.5" D

Weight

DSX-1044 1.2 lb.

Finish

Black Powder Coat with White Silkscreen on Enclosure
Black Nylon with White Silkscreen on DSX-1044

Temperature

Operating 32 to 131 F
Storage -35 to 150 F

Humidity

Operating 0 to 95%, relative

Power Requirements

DSX-1044 13.5 VDC @ 550ma from 1040CDM

Inputs

Supervised 32
2, 3, 4 State Monitoring

UL Installations require a Tamper Switch to be connected to an Input programmed with a 24hr Time Zone.

Outputs

Digital (open collector) 4
Output Ratings 12VDC @ 100ma sinking

Communication Ports

RS-232 In - 1 Master to PC
RS-232 Out - 1 Panel to DSX-1040CDM

Processor

RDC186 20Mhz

RAM/ROM Memory

Flash ROM 512K
Standard RAM 512K
Non-Volatile Memory is available for new and existing controllers.

Warranty

Limited 2 Years



DSX-LAN-D

LAN Communications Module

- **Web Interface for configuration**
- **Admin and User Complex Passwords**
- **Transmitted Security Log**
- **RS-232/485 Outputs - Diagnostic LEDs**
- **UDP Protocol with definable Socket**
- **Powered from DSX Controller**



General Purpose

The DSX-LAN module is used to provide Local or Wide Area Network Communications between the Comm Server PC and Master Controller. The DSX software is inherently TCP/IP capable and can direct communications to a specific IP address and UDP port number. The DSX-LAN module receives that communication and converts it to RS-232 or RS-485 that connects directly to the Master Controller.

The DSX-LAN can also be used with a Sub Controller or a cluster of Sub Controllers with the use of the DSX-IP-HUB at the Master Controller. The IP-HUB is an appliance that routes Sub Panel Communication to LAN modules installed at Sub Controllers.

The DSX-LAN module security provides an Admin and User Password of 6-19 characters with user definable complexity. The User password can change the network settings and the Admin password can change network and security settings. The Security Log feature allows for an optional IP Address and Port to be defined (not the Comm Server). Once defined, the module will send all Login attempts and notification of changes made to that Log address. The module can also send a supervisory heartbeat message to this same address at a user definable frequency.

Power

The DSX-LAN is powered from the Controller or 1040 CDM. The module can be powered from 5-12VDC requiring a mere 350ma. Powering the module from the DSX Controller provides a good stable battery backed up source. 5Volt output is preferred.

Mounting

The DSX-LAN is designed to fit in the same Equipment Cabinet as the DSX-1048 and DSX-1022 Controllers. It can mount on the inside or rest in the bottom of the enclosure. It has three mounting holes and removable terminal blocks for ease of installation.

Size

4.75" H x 2.8" W x 1.5" D

Weight

7.5 oz.

Temperature/Humidity

Operating 0 to 70 C

Power Requirements

DC Input Voltage 5-12VDC @ 350ma
5VDC preferred



DSX-IP-HUB

LAN Distribution Module

- **Web Interface for configuration**
- **Admin and User Complex Passwords**
- **Transmitted Security Log**
- **UDP Protocol with definable Socket**
- **Powered from DSX Controller or CDM**



The DSX-IP-HUB is a module that connects to the Master Controller and to the Network and allows Sub Controller Communication to be routed via IP through the network to standard DSX-LAN modules connected to Sub Controllers or clusters of Sub Controllers.

The DSX-IP-HUB allows Controller Communication to be IP via the LAN without the use of PC Master Software. In fact, the IP-HUB can be used in some cases to replace PC Master software by adding or reconfiguring an existing panel to be a Master Controller and attaching a DSX-IP-HUB to it. The Sub Controllers use standard DSX-LAN modules and would only require minor reprogramming to allow communication with the new Master Controller through the IP-HUB.

Size
4.75" H x 2.8" W x 1.5" D

Weight
7.5 oz.

Temperature/Humidity
Operating 0 to 70 C

Power Requirements
DC Input Voltage 5-14VDC @ 350ma

Warranty
Limited 2 Years

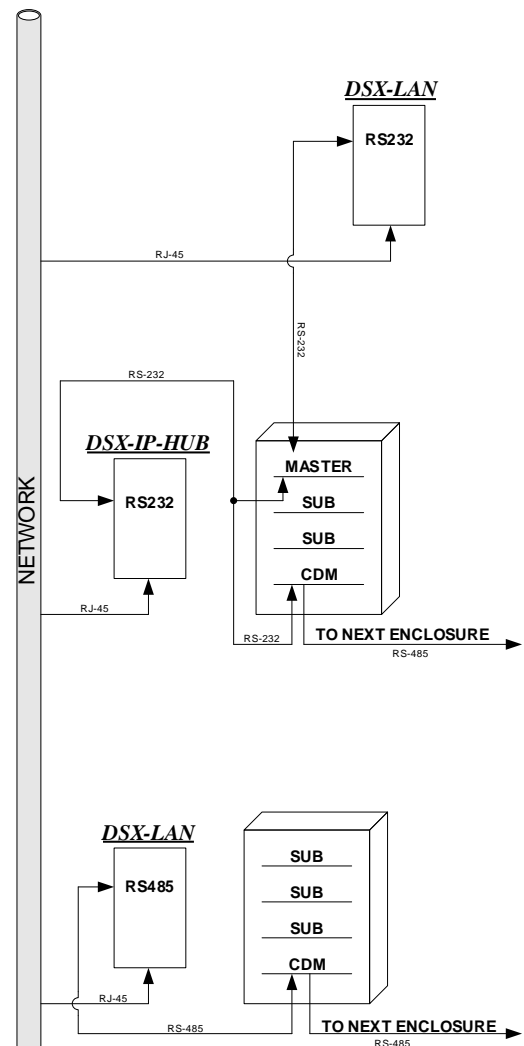



DSX Software

PC Hardware Requirements

DSX, DSX-SQL, PC Master, L85 and SIO are compatible with the latest and most recent Windows Platforms. PC Hardware and Operating Systems for these applications are outlined below. The hardware requirements are a minimum specification, which can always be exceeded if desired. All PCs used in the DSX system must meet these minimum requirements for the system to be supported by DSX.

Note /// System performance is dependent on the PC and LAN processing speed. If you have any questions regarding the DSX software and PC requirements, please call DSX Technical Support. This PDF, located on the DSX Website, supersedes all other disseminations.

CPUs Minimums	Application
Intel i3 Dual Core (equivalent or better)	Single Comm Server No Clients 1 Location 4GB RAM - Minimum
Intel i5 Quad Core (equivalent or better)	Single Comm Server, Multiple Clients Multiple Locations 6GB RAM - Minimum
Intel i7 Quad Core (equivalent or better)	Primary and Backup - - Comm Servers -SQL Multiple Clients Multiple Locations 8GB RAM - minimum
Memory Minimums	Application
4-8GB	Basic System, Single PC
8GB+	Multi-Location Comm Server and Badging
Drive Minimums	Application
USB Port for Flash Drive	Software Installation
1G Hard Drive Space minimum	DSX Install requires 100M SQL Databases require 300M
Monitor	Application
1024 x 768 or better	Badging, Maps
17" or larger recommended	

LAN Communications	
Adapter 100Mbit or better	100M or better recommended
Requires TCP/IP Protocol	Use MS Loopback Address if there is no LAN
Comm Server	Static IP Address -required
LAN Modules	Static IP Address -required
Comm Server to Controller	UDP - ports 4000 to 5000
Comm Server to Workstation	TCP - ports 22223 / 22224
Mobile Service (optional)	TCP 60001-60002 configurable
Sound	Application
Windows™ compatible sound card.	DSX can play WAV files for input alarms.
Backup Gear	Application
Windows™ compatible Backup gear.	DSX can send backups to logical drive. DSX SQL uses SQL Server for backups.
Modem	
DSX External dial-up	DSX Modems are the only modems supported by DSX.
Serial Ports	
DSX-USB USB to RS-232 / RS-485.	Used for Direct and Dialup communications.
Client Operating Systems	DSX Version
Windows™ 10 1809	5.0.22 / 6.0.22 and higher
Pro +64 bit	
The Comm Server can run on a Client Operating System.	
Server Operating Systems	
Server 2012 R2	3.9 / 4.9 and higher
Server 2016	5.0.22 / 6.0.22 and higher
Server 2019 CU1	5.0.22 / 6.0.22 and higher
Server Operating Systems	Require Active Directory
SQL Server	
SQL 2012 sp3	4.9 and higher
SQL 2014 sp2	4.10 and higher
SQL 2016 sp1	6.0.22 and higher
SQL 2017 CU9	6.0.22 and higher
SQL 2019 CU1	6.0.22 and higher
TLS 1.2 w SQL2016 and >	6.2.24 and higher
Dependencies	
Access and SQL	.Net Framework 4.0 and >
SQL	SQL Native Client - provided



DSX Access Systems Inc.

Security Professional's First Choice